



SPV Pump Installation & Operating Instructions

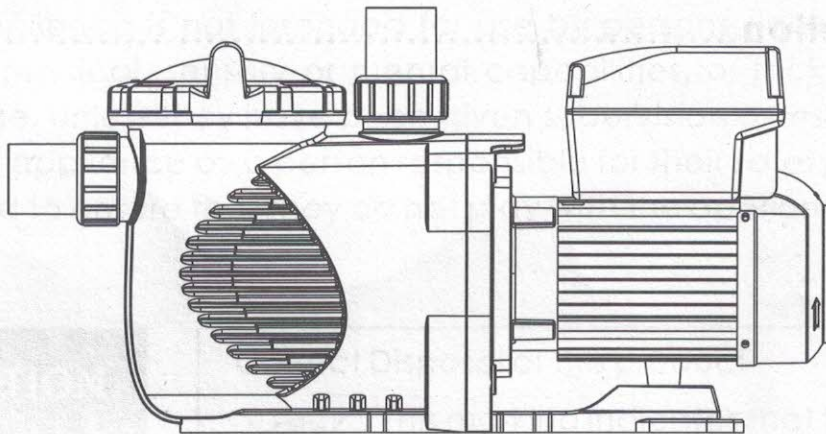

TABLE OF CONTENT

Warnings.....	3
Pump Installation.....	4
User' s Guide.....	4-5
Menu structure.....	6-7
Programming.....	8
Fault treatment.....	9
Operating Procedure.....	9-13
Routine Maintenance.....	13
Service & Repair Parts.....	13
Trouble Shooting.....	14
Replacement Parts.....	15
Overall Dimension.....	16
Product Information.....	16

WARNINGS:

⚠ CAUTION:

THE PUMP SHOULD BE INSTALLED ACCORDING TO YOUR LOCAL ELECTRICAL INSTALLATION ORDINANCES AND REGULATIONS.

ONLY QUALIFIED, LICENSED PERSONNEL SHOULD INSTALL PUMP AND WIRING.

- 1) Locate pump as close to pool as possible, preferably in a dry, well ventilated area away from direct sunlight. Pump Mount must:
 - * Be on solid, level, rigid and vibration free surface. Secure pump to base with screws or bolts to further reduce vibration and stress on pipe or hose joints
 - * Allow pump suction inlet height to be as close to water level as possible.
 - * Allow use of short, direct suction pipe (To reduce friction loss.)
- 2) Fix the pump by screws onto the platform.
- 3) Connect the suction and discharge pipe to the outlet and inlet of the swimming pool.
- 4) The installation instructions shall provide information on requirements specified for the electrical installation and shall include reference to national wiring rules.
- 5) The installation instructions shall state the substance of the following: - the maximum total head, in metres (Hmax:20m)
- 6) the pump is to be supplied through a residual current device (RCD) having a rated residual operating current not exceeding 30 mA.

⚠ This appliance is not intended for use by persons (including children) with reduced physical, sensory or mental capabilities, or lack of experience and knowledge, unless they have been given supervision or instruction concerning use of the appliance by a person responsible for their safety. Children should be supervised to ensure that they do not play with the appliance.



Correct Disposal of this product



This marking indicates that this product should not be disposed with other household wastes throughout the EU. To prevent possible harm to the environment or human health from uncontrolled waste disposal, recycle it responsibly to promote the sustainable reuse of material resources. To return your used device, please use the return and collection systems or contact the retailer where the product was purchased. They can take this product for environmental safe recycling.

1 Pump Installation

- * Please install on a level vibration free surface.
- * Allow use of short, direct suction pipe. (To reduce friction losses & don't install the pump at more than 3M geometrical height from water level)
- * Allow for gate valves in suction and discharge piping if required.
- * Have adequate floor drainage to prevent flooding.
- * Protect from excess moisture.
- * Allow the adequate access for servicing pump and piping.

NOTICE:

Pump suction and discharge connections have molded in thread stops, DO NOT try to screw pipe in beyond these stops.

1.1 Operation

The pump is fitted with a wide range of settings to suit any filtration requirements. The controller is used to program a range of motor speeds and settings described as "Schedules" in the program. To program the pump go to page 5 for easy description of how this is done. **NEVER** run pump dry! Running pump dry may damage seals, causing leakage and flooding! Fill pump with water before starting motor.

Before removing lid:

- * STOP PUMP before proceeding.
- * RELEASE ALL PRESSURE from pump and piping system.
- * NEVER tighten or loosen screws while pump is operation.
- * Do not block pump suction!

1.2 Priming Pump:

- * Release all air from filter and piping system: see filter owner manual.
- * In a flooded suction system (water source higher than pump), pump will prime itself when suction and discharge valves are opened.
- * If pump is not in a flooded suction system, unscrew and remove pump lid and fill with water.

NOTICE: Tighten pump lid by hand only.

2. User's Guide

2.1 Overview

This controller match with the variable speed drive for the swimming pool variable speed pump, Functions as shown below:

- 1) Timer: Built in real time clock.
- 2) Control Parameters: Power usage and motor running speed (RPM) display.
- 3) Preset Running Speed: 3 preset running speeds.
- 4) Parameter Setting: Real time clock, 3 preset running speeds, 3 schedule settings, self priming setting.
- 5) Error Display: Over Current, Over Voltage, Under Voltage, Overheating fault code.
- 6) Auto Recovery: Over Current, Over Voltage, Overheating, Power failure, restore to the settings before the error.
- 7) Power Failure Recovery: When power resume from failure, will restore to the settings before the power failure.

2.2 Controller outlook display

2.2.1 Interface Display Diagram

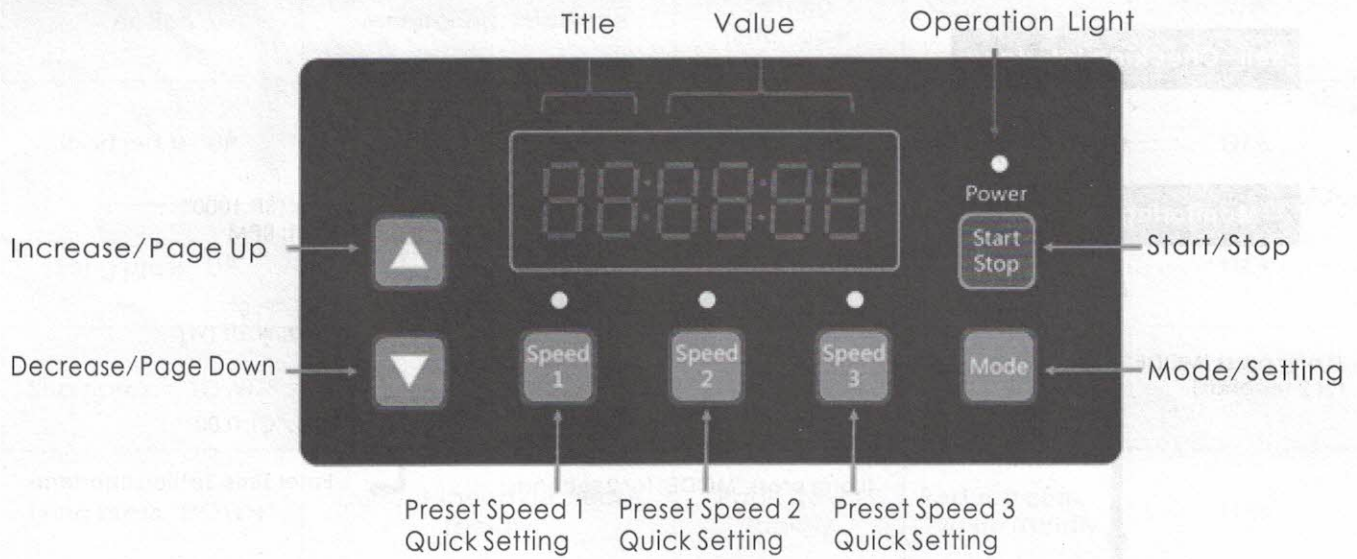

2.2.2 Indication Light Reference

	S1	S2	S3	Running Light	Operation Light Flashing
Preset Speed 1 Enable	1	0	0	X	0
Preset Speed 2 Enable	0	1	0	X	0
Preset Speed 3 Enable	0	0	1	X	0
In Operation	X	X	X	1	0
Warning	1	1	1	1	1

Remark: "1" Light On, "0" Light Off, "X" N/A

(Chart 2.1)

3. Menu structure

3.1 Program Flow Chart

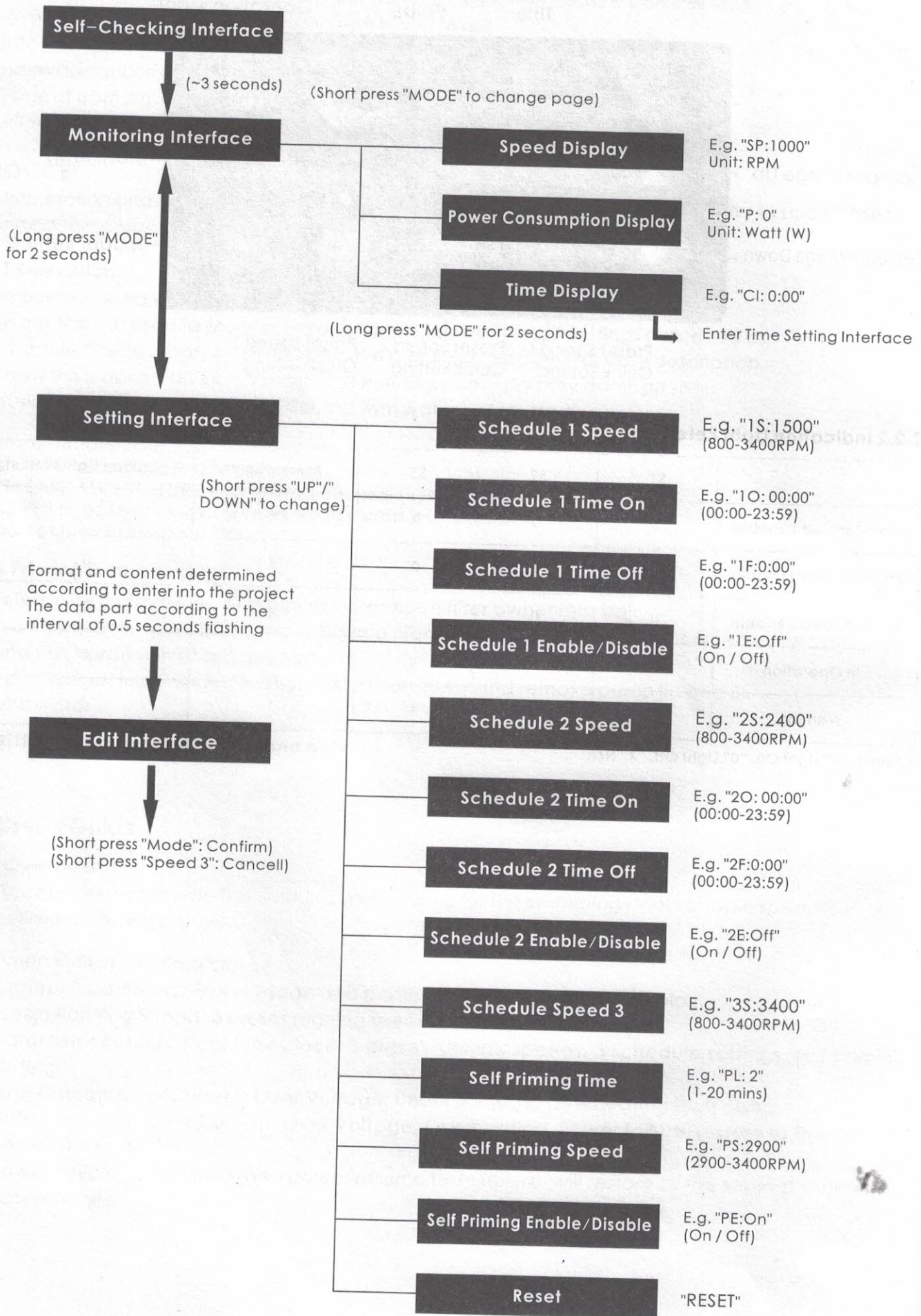

3.2 Buttons Control

Action	Monitoring Interface	Setting Interface	Edit Interface	Error/Auto Recovery
Short press "UP"	Current speed +10rpm	Page Up	Add current value	N/A
Long press "UP"	Current speed increase rapidly	Page Up rapidly	Add current value rapidly	N/A
Short press "DOWN"	Current speed -10rpm	Page Down	Reduce current value	N/A
Long press "DOWN"	Current speed decrease rapidly	Page Down rapidly	Reduce current value rapidly	N/A
Short press "MODE"	Change page	Enter Edit Interface	Confirm change, back	N/A
Long press "MODE"	When in the Time Display page: Enter Time Setting When in other pages: Enter Setting Interface	Enter Monitoring Interface	N/A	N/A
Short press "Start/Stop"	Start / Stop	Start / Stop	N/A	Auto Recovery
Long press "Start/Stop"	N/A	N/A	N/A	N/A
Short press "Speed 1"	Set current speed to preset speed 1	Switch to preset speed 1	Edit cursor move left	N/A
Long press "Speed 1"	N/A	N/A	Edit cursor move left rapidly	N/A
Short press "Speed 2"	Set current speed to preset speed 2	Switch to preset speed 2	Edit cursor move right	N/A
Long press "Speed 2"	N/A	N/A	Edit cursor move right rapidly	N/A
Short press "Speed 3"	Set current speed to preset speed 3	Switch to preset speed 3	Cancel change, back	N/A
Long press "Speed 3"	N/A	N/A	N/A	N/A

(Chart 3.1)

4 Programming

4.1 Programmed Schedule

- 1) 2 schedule settings available, preset speed at 1500RPM, 2400RPM.
- 2) Each schedule setting has 4 parameters "Running Speed", "Time On", "Time Off", Enable / Disable.
- 3) Programmed Schedule Priority: Schedule 1 > Schedule 2 .
- 4) Programmed Schedule Logic: If more than 1 schedule is enabled within the same time period, the controller will operate only with the highest priority schedule and speed, the corresponding indication light will on.
- 5) Programmed Schedule Termination: If all schedules are completed with its setting time, the controller will switch back to the condition before the schedule.
- 6) Programmed Schedule Manually Disable: When any programmed schedule is running, press any button ("UP", "DOWN", "Start/Stop", "Speed 1", "Speed 2", "Speed 3") in the monitoring interface with disable all programmed schedules. (Press "Start/Stop" will stop the pump, the last running speed will be recorded, the operation light will remain; Press "UP", or "DOWN", running speed add/reduce 10rpm from the current speed, the operation light will off; Press "Speed X", the selected speed will replace the current speed, with the corresponding speed indication light on)
- 7) The scheduled settings and auto recovery will not contradict each other. When there is error, the variable speed driver will restore to the settings before the error. (The priority setting is still applicable)

4.2 Self Priming

- 1) Self Priming setting has 3 parameters "Self Priming Time", "Self Priming Speed", "Enable/Disable".
- 2) Self Priming function will be activated if the function is enable, the running speed is lower than the "Self Priming Speed" and the running time is less than the "Self Priming Time".
- 3) Self Priming default as "Enable".

4.3 Auto Recovery

- 1) Auto Recovery is a core function, with no setting options.
- 2) When there is Over Current, Over Voltage or Low Voltage error, the variable speed driver will recover automatically and will restart after 10 seconds.
- 3) In the first 5 seconds, the display will shows the "error details /error times" (e.g. "OC1 1T"). In the next 5 seconds, the display will shows the "Count down details / Count down time" (e.g. "AR 5" or "AS 5")
- 4) If two errors happened in less than 60 seconds interval, the auto recovery time will increase once. If the auto recovery increase to 3 times, the system will direct to the Error menu, and will not auto recover.
- 5) Press "Start/Stop" button to cancel the count down during the auto recovery process, to activate the auto recovery immediately.

4.4 Power Failure Recovery

- 1) The current settings (Enable/disable, current speed, scheduled settings) are protected by the capacitance, the memory will be kept for 72 hours.
- 2) When the power is reconnected, the variable speed driver will restore to the settings before the error.

4.5 Real Time Clock

- 1) Real time clock display time in "hours:minutes"
- 2) Long press "MODE" button at the "Time Display Page" to enter "Time Setting".

4.6 Reset

At the setting interface, switch to the Reset menu, display "RESET", short press "Mode", the

content flash, short press "Mode" again, reset complete. Short press "Speed 3" while the content is flashing to stop the reset.

5 Fault treatment

5.1 Communication error

When there is communication error between the controller and the variable speed driver, an error code "ER...." will be displayed.

5.2 Error Display

When the Controller is not working, a fault code will be shown on the controller display, E.g. "ER OV".

Press "Start/Stop" button will restore the controller.

Below the common fault code list:

Error	Description	Reason
OC	Over Current: Driver's output current exceeds the threshold (200% of rated current)	<ul style="list-style-type: none"> • Driver output failure • Driver IPM module is damaged
OV	Over Voltage: Main circuit DC voltage exceeds the threshold	<ul style="list-style-type: none"> • Over power of the power supply • Power supply voltage exceeds controller setting
UV	The main electric current is too low Under Voltage:	<ul style="list-style-type: none"> • Power supply disconnected, driver discharging • Supply voltage fluctuation it too large
OH	Motor heat sink overheating Over Heat:	<ul style="list-style-type: none"> • Ambient temperature is too high • Motor Cooling Fan does not work

(Chart 5.1)

6 Operating Procedure

6.1 Starting

After starting, the driver will run the self-checking procedure by scanning the display and the operation light, as diagram 6.1.

When there is communication error between controller and the variable speed driver, communication error will be displayed, as diagram 6.2.

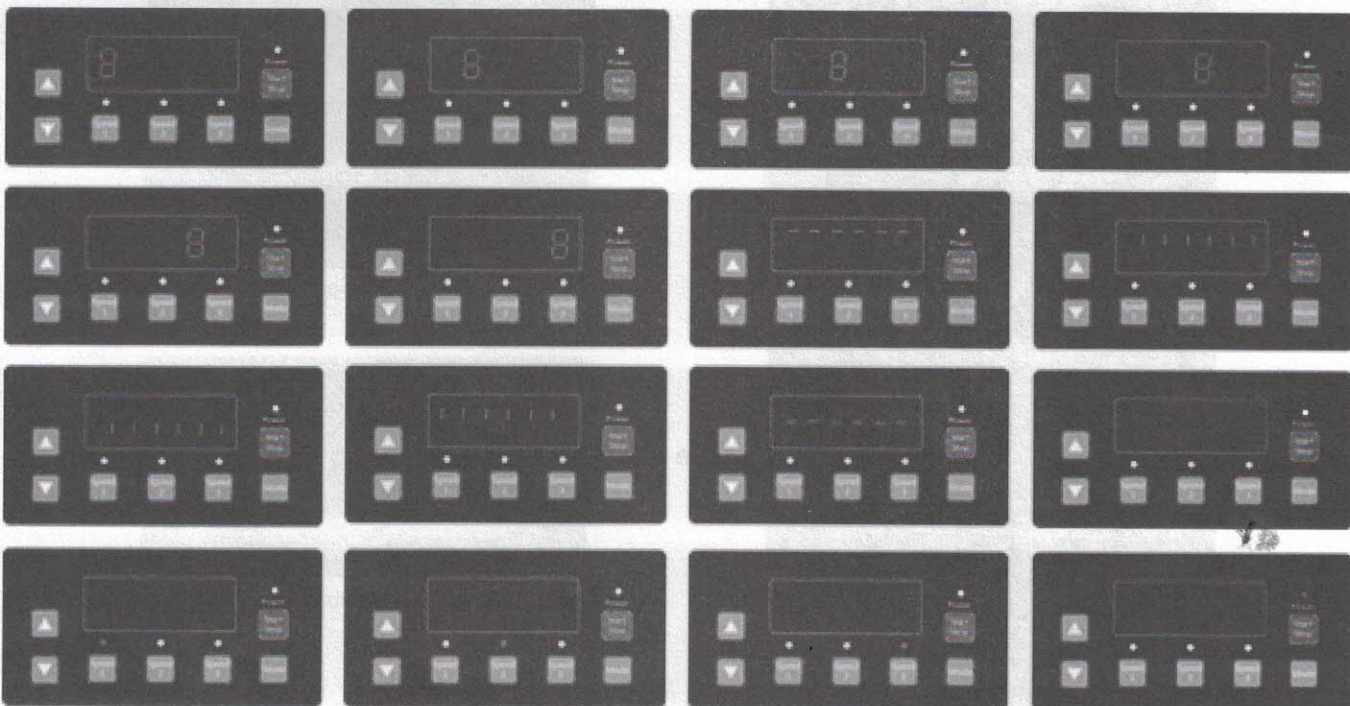

(Diagram 6.1, Self-checking procedure)

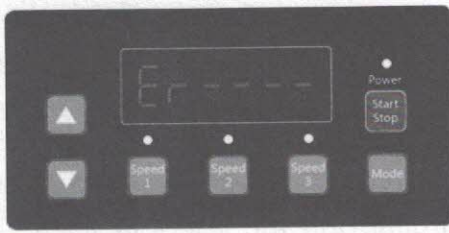

(Diagram 6.2, Communication Error)

6.2 Monitoring Interface

After starting, enter Monitoring Interface. As diagram 6.3.

Short press "Mode" to interchange between speed or time display page. As diagram 6.3-6.5.



(Diagram 6.3, Speed display page)

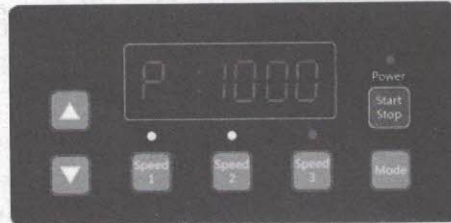

(Diagram 6.4, Power consumption display page)



(Diagram 6.5, Time display page)

Short press "Speed1" to "Speed3", to switch to the 3 preset speeds, the corresponding indication light will on, as diagram 6.6-6.8.



(Diagram 6.6, Speed 1)



(Diagram 6.7, Speed 2)



(Diagram 6.8, Speed 3)

At any time press "Run", to stop/start the variable speed driver, and light on/off the operation light.



(Diagram 6.9, Power consumption display, Speed 3)

At any time press "Up" or "Down", to add or reduce the rpm by 10, as diagram 6.10-6.11.



(Diagram 6.10, 1000rpm press "Up" once)



(Diagram 6.11, 1000rpm press "Down" once)

Long press "Mode", to enter the setting interface, as diagram 6.12.

6.3 Setting Interface

Short press "Mode" to interchange between "Schedule 1 Speed", "Schedule 1 Time On", "Schedule 1 Time Off", "Schedule 1 Enable/Disable", "Schedule 2 Speed", "Schedule 2 Time On", "Schedule 2 Time Off", "Schedule 2 Enable/Disable", "Schedule 3 Speed", "Self Priming Time", "Self Priming Speed", "Self Priming Enable/Disable", "Auto Recovery" pages. As diagram 6.12-6.23.



(Diagram 6.12, Schedule 1 Speed, default 1500rpm)



(Diagram 6.13, Schedule 1 Time On, default 00:00)



(Diagram 6.14, Schedule 1 Time Off, default 00:00)



(Diagram 6.15, Schedule 1 Enable/Disable, default Off)



(Diagram 6.16, Schedule 2 Speed, default 2400rpm)

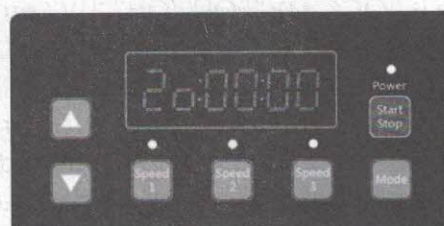

(Diagram 6.17, Schedule 2 Time On, default 00:00)



(Diagram 6.18, Schedule 2 Time Off, default 00:00)

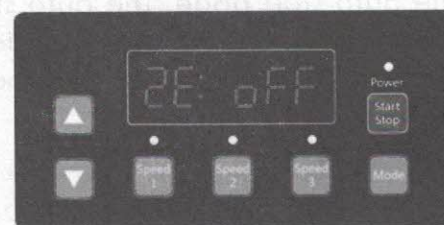

(Diagram 6.19, Schedule 2 Enable/Disable, default Off)



(Diagram 6.20, Schedule 3 Speed, default 3400rpm)

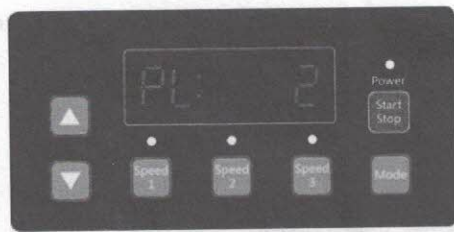

(Diagram 6.21, Self Priming Time, default 2 mins)

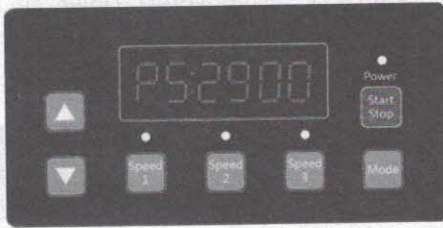

(Diagram 6.22, Self Priming Speed, default 2900rpm)

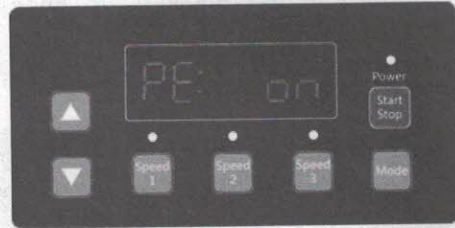

(Diagram 6.23, Self Priming Enable/Disable, default On)



(Diagram 6.24, Reset)

Short press "Speed 1" "Speed 2" "Speed 3" to switch to "Schedule 1 Speed", "Schedule 2 Speed" or "Schedule 3 Speed".

6.4 Edit Interface

Long press "Mode" at the time display page under monitoring interface or short press "Mode" at any display page to enter the edit interface.

At the edit interface, the changeable area will flash, press "Up" or "Down" to change the value, press "Speed 1" or "Speed 2" to move left or right.

When editing, short press "Mode" to confirm, or short press "Speed 3" to cancel.

6.5 Auto Recovery

When there is "OC""OV""OL""OH""UV" error, the system will recovery automatically. If two errors happened in less than 60 seconds interval, the auto recovery time will increase once. If the auto recovery increase to 3 times, the system will direct to the Error menu, and will not auto recover.

The Auto Recovery page will display the error details (diagram 6.25) in the first 5 seconds and the count down details in the next 5 seconds (diagram 6.26)

Press "Start/Stop" button to cancel the count down during the auto recovery process, to activate the auto recovery immediately. (without activate the auto run.

If there is error and the variable speed driver is in operation, then after auto recovery the system will enter the auto start page. The auto start page will display the error details (same as auto recovery, last for 5 seconds) and count down details (diagram 6.27, last for 5 seconds). At any time, short press "Run" to cancel the procedures and auto recover immediately (the variable speed driver will default Off).



(Diagram 6.25, Auto Recovery, error details OC1, error time 1)

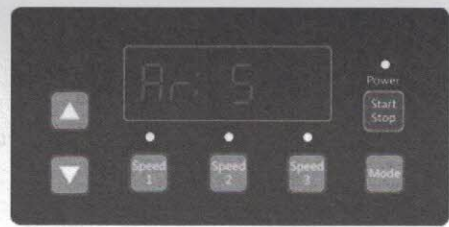

(Diagram 6.26, Auto Recovery count down, 5 seconds remaining)



(Diagram 6.27, Auto Start count down, 5 seconds remaining)

6.6 Error Menu

Error Menu display as diagram 6.28, error details will be displayed and all lights will be flashing. Short press "Run" at the error menu, to auto recover the variable speed driver (keep the driver Off).



(Diagram 6.8 Error, Error code OC1)

7 Routine Maintenance

The only routine maintenance needed is inspection/cleaning of trap basket. Debris or trash that collects in basket, will choke off water flow through the pump. Follow instructions below to clean trap:

- 1) Stop pump, close gate valve in suction and discharge, and release all pressure from system before proceeding.
- 2) Unscrew trap lid (turn counterclockwise).
- 3) Remove strainer basket and clean. Be sure all holes in basket are clear, flush basket with water and replace in trap with large opening at pipe connection port (between ribs provided). If basket is replaced backwards cover will not fit on trap body.
- 4) Clean and inspect lid Ring; reinstall on trap cover.
- 5) Clean Ring groove on trap body and Replace lid. To help keep lid from sticking, tighten hand tight only.
- 6) Prime pump (see priming instructions above)

8 Service & Repair Parts

Refer all service to your local agent or dealer as his knowledge of your equipment makes him the vest qualified source of information. Order all repair parts through your dealer. Give the following information when ordering repair parts:

- 1) Unit nameplate data or serial number on label.
- 2) Description of part.

9 Trouble Shooting

MOTOR DOES NOT START

- 1) Disconnect switch or circuit breaker in off position
- 2) Fuses blown or thermal overload open
- 3) Locked motor shaft
- 4) Motor windings burned out
- 5) Defective starting switch inside single phase motor
- 6) Disconnected or defective wiring
- 7) Low voltage

PUMP DOES NOT REACH FULL SPEED

- 1) Low voltage
- 2) Pump connected for wrong voltage

MOTOR OVERHEATS (protector trips)

- 1) Low voltage
- 2) Motor windings connected for wrong voltage on dual voltage model
- 3) Inadequate ventilation

PUMP DELIVERS NO WATER

- 1) Pump is not primed
- 2) Closed valve in suction or discharge line
- 3) Leakage or air into suction system
- 4) Impeller clogged

LEAKAGE OF WATER AT SHAFT

- 1) Shaft seal requires replacement

LOW PUMP CAPACITY

- 1) Valve in suction or discharge line partly closed
- 2) Suction or discharge line partly plugged
- 3) Suction or discharge line too small
- 4) Plugged basket in skimmer or hair and lint strainer
- 5) Dirty filter
- 6) Impeller clogged

HIGH PUMP PRESSURE

- 1) Discharge valve or inlet fittings closed too much
- 2) Return lines too small
- 3) Dirty filters

NOISY PUMP AND MOTOR

- 1) Plugged basket in skimmer or hair in lint strainer
- 2) Worn motor bearings
- 3) Valve in suction line partly closed
- 4) Suction line partly plugged
- 5) Vacuum hose plugged or too small
- 6) Pump not supported properly

AIR BUBBLES AT INLET FITTINGS

- 1) Leakage of air into suction line at connections or valve stem
- 2) Cover gasket of hair and lint strainer needs cleaning
- 3) Low water level in pool

NOTE: If the recommendations in the trouble shooting portion of this manual do not solve your particular problem(s), please contact your local dealer for service.

10 Replacement Parts

10.1 Parts Diagram

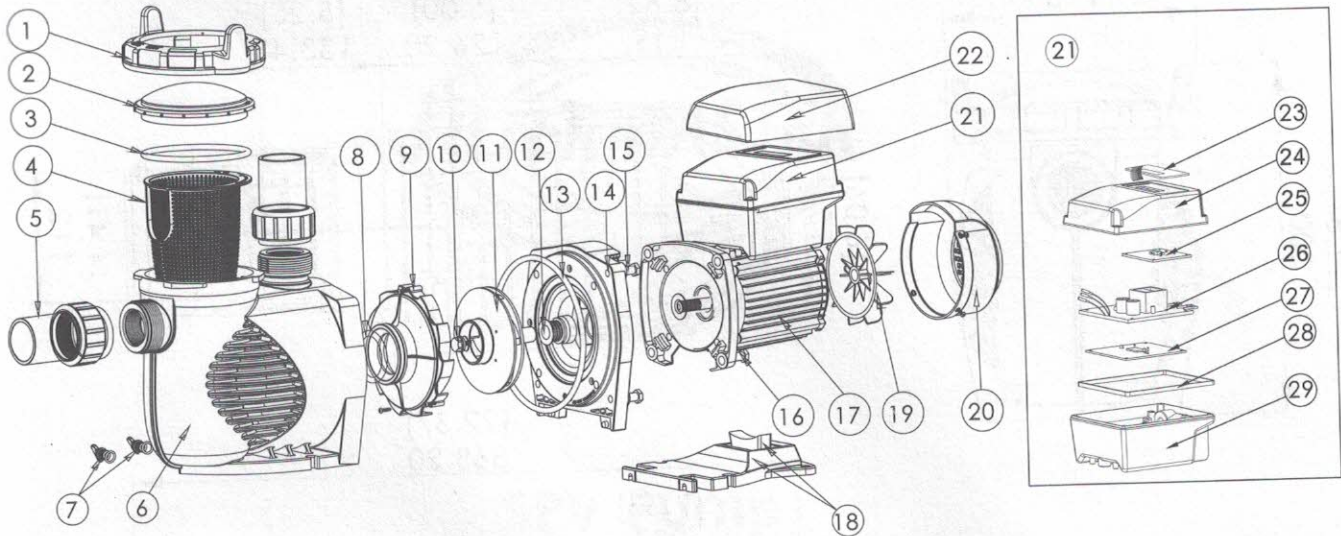

10.2 Parts Listing

Item NO.	Part NO.	Product Description	Qty
1	01021143	Nut For Lid	1
2	01041057	Transparent Lid	1
3	02010253	O-Ring For Lid	1
4	01112080	Basket	1
5	89023801	1.5"Union	2
6	01021144	Pump body	1
7	89021307	Drain Plug With O-ring	2
8	02010245	O-Ring For Diffuser	1
9	01112081	Diffuser	1
10	89020719	Screw for impeller with O-ring	1
11	01311058	Impeller For EPV150 &SPV150	1
12	04015046	3/4"Mechanical seal	1
13	02010246	O-Ring for Flange	1
14	01021145	Flange	1
15	89020720	M8*35 Screw with Washer For Motor	4
16	03011075	M8*30 Screw	4
17	04020140	SPV150 motor	1
18	01112082	Base	1
18	02010211	Arch Cushion for Base	1
19	01031027	Fan	1
20	01321032	Fan Cover	1
21	89023901	Controller For SPV150	1
22	01041061	Lid for Controller	1
23	04015057	Switch keys	1
24	03039920	Cover for Programmable Controller	1
25	04015060	SPV operation panel (PCB)	1
26	04015061	PFC PCB	1
27	04015062	Driver	1
28	02021092	Cushion for Cover	1
29	03039919	Shell for Programmable Controller	1

11 Overall Dimension

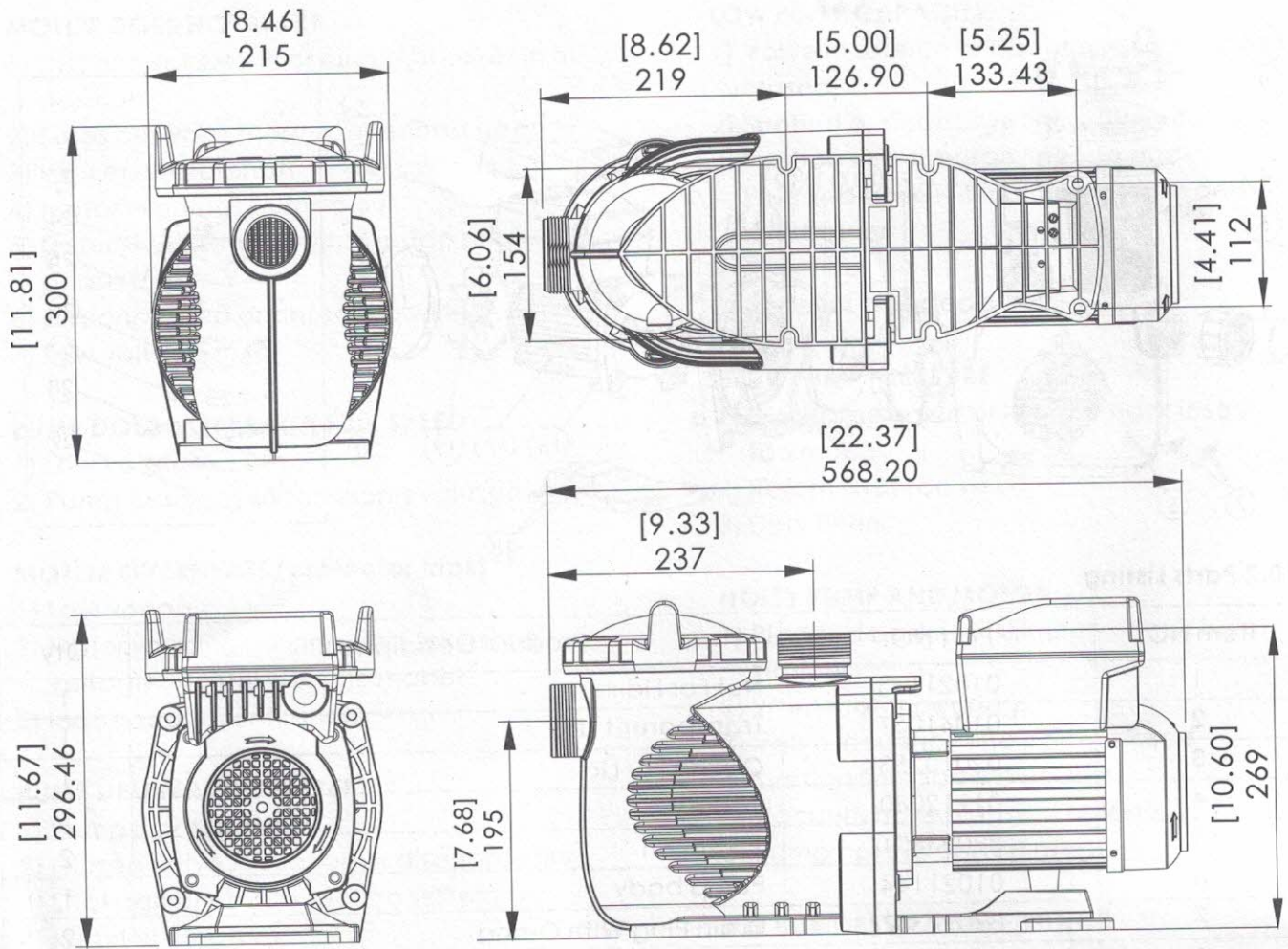

12 Product Information

Code	Mode Code	Connection	Input Power	Horsepower	RPM
88029807	SPV150	1.5" 50mm	1.3 kW	1.5HP	800-3400rpm